

Clock Generation

Title		SoCrtas Cyclone V-Soc Evaluation Board	
Size	Number	Rev	
A3	SoCrtas	1.1	
Date	09.03.2013	Drawn by	
Filename	SoCrtas.sch	Sheet 2 of 10	

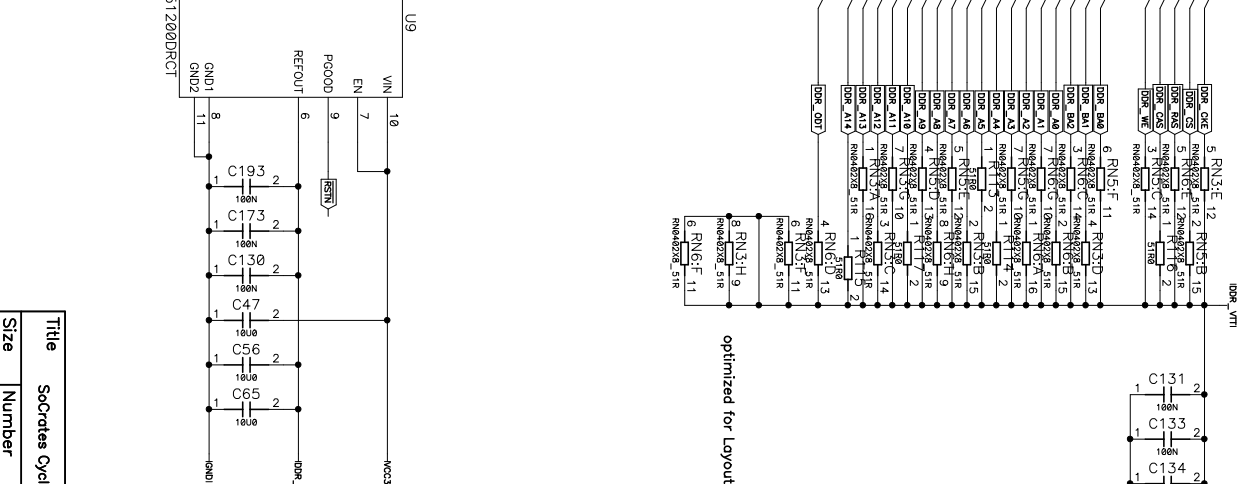

optimized for layout

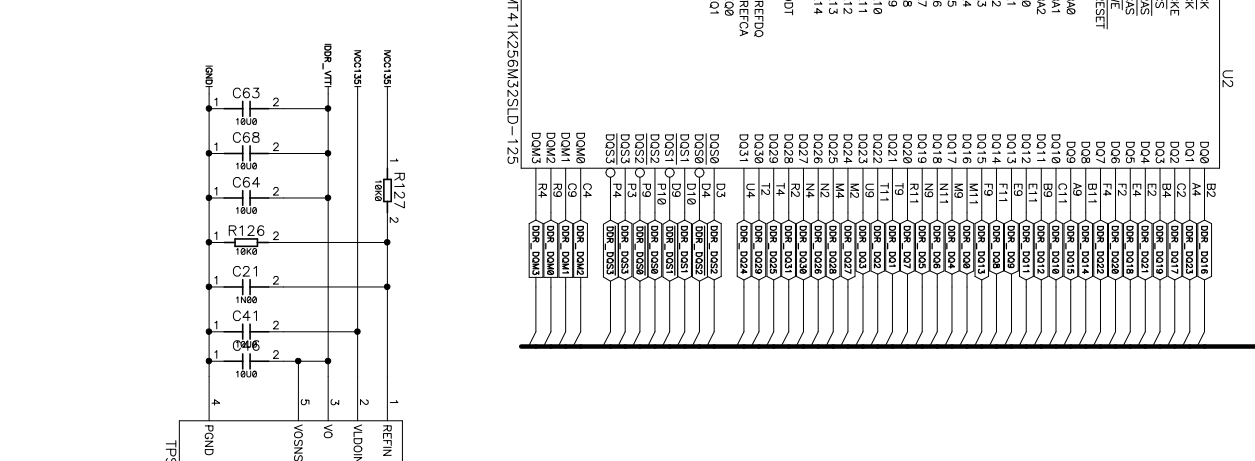
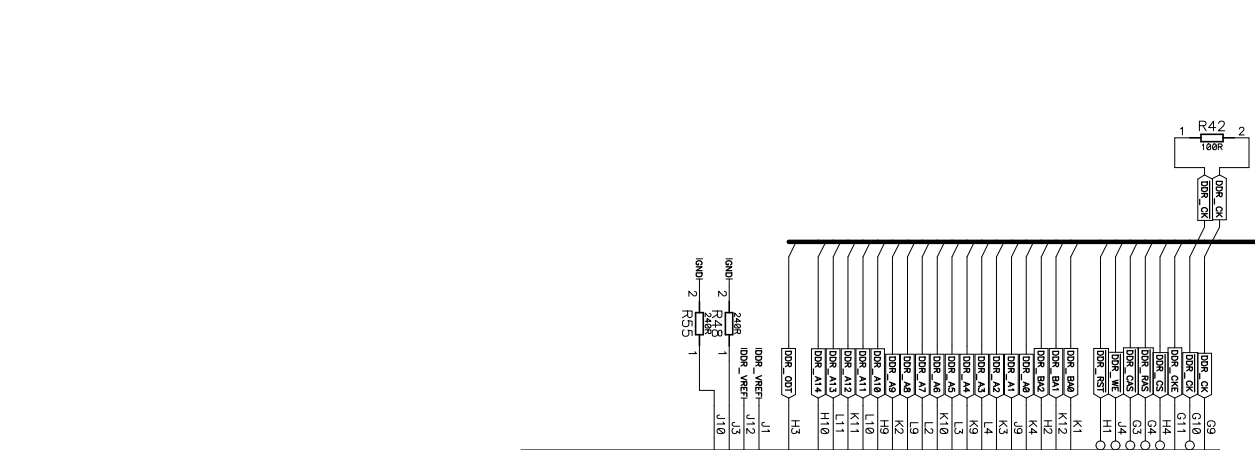
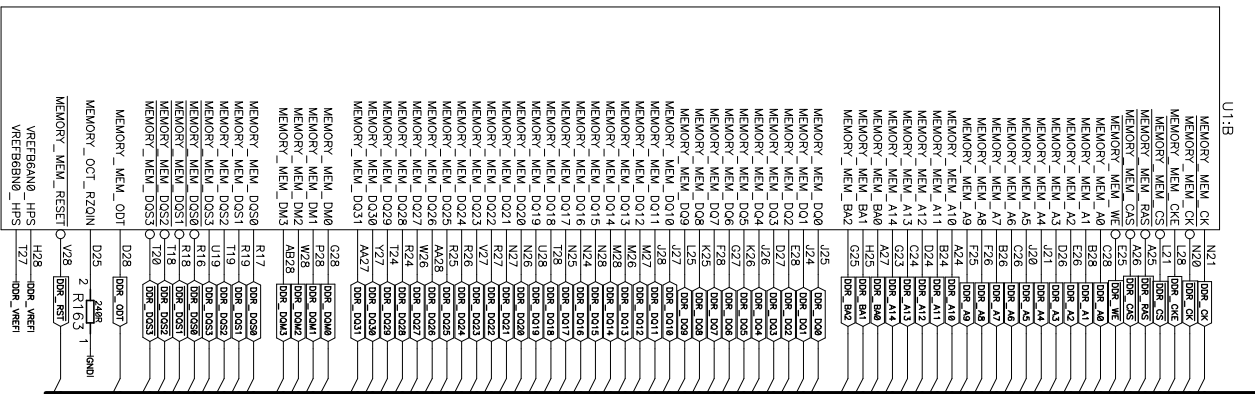

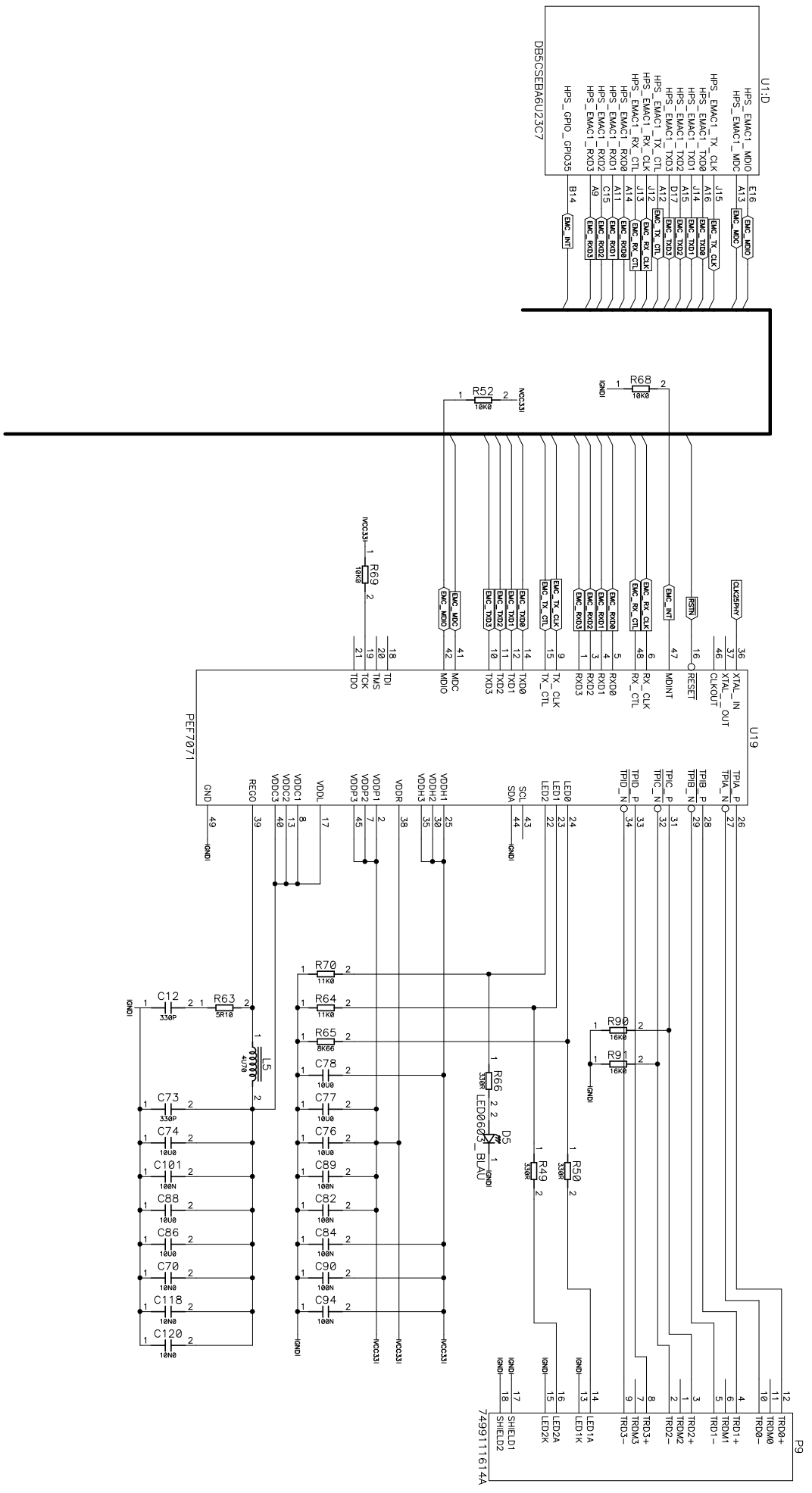

HPS Gigabit Ethernet Phy

Title		SoCrtcs Cyclone V-Soc Evaluation Board	
Size	Number	Rev	
A3	SoCrtcs	1.1	
Date	09.03.2013		Drawn by
Filename	SoCrtcs.sch		Sheet 5 of 10

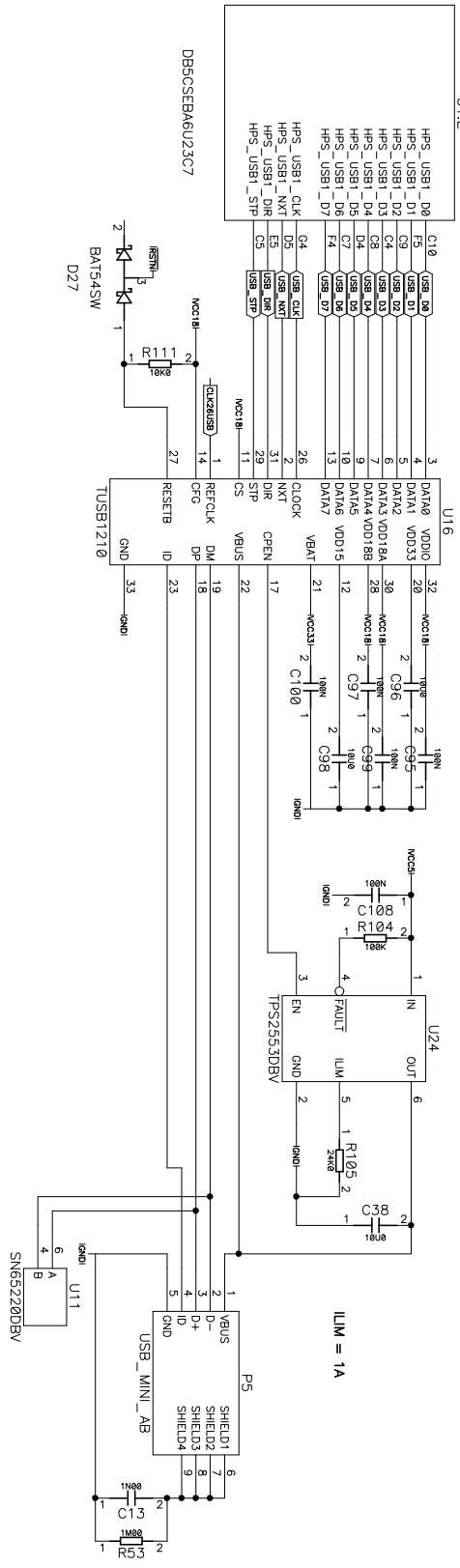

HPS - USB Interface

Title		SoCrtcs Cyclone V-Soc Evaluation Board	
Size	Number	Rev	
A3	SoCrtcs	1.1	
Date	Drawn by		
09.03.2013	SoCrtcs		
Filename	SoCrtcs.sch	Sheet	6 of 10

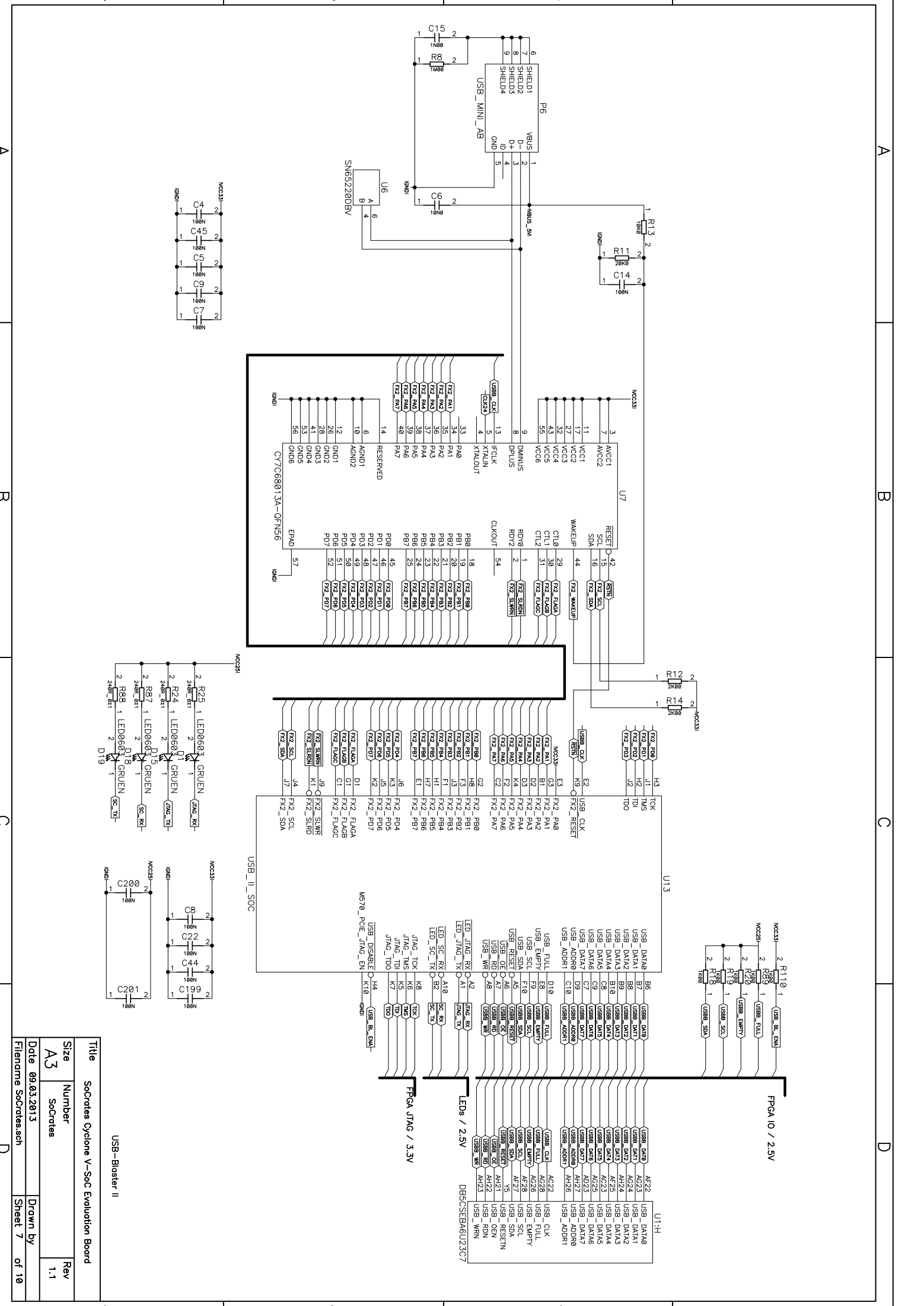

Title		SoCretes Cyclone V-Soc Evaluation Board	
Size	Number	Rev	
A3	SoCretes	1.1	
Date	09.03.2013	Drawn by	
Filename	SoCretes.sch	Sheet	7 of 10

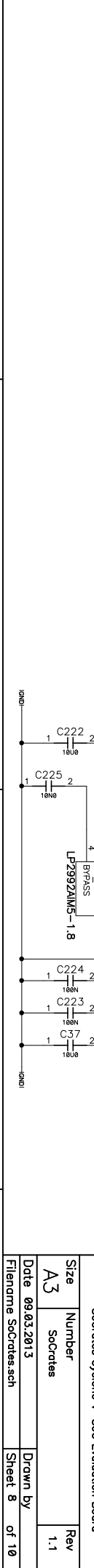
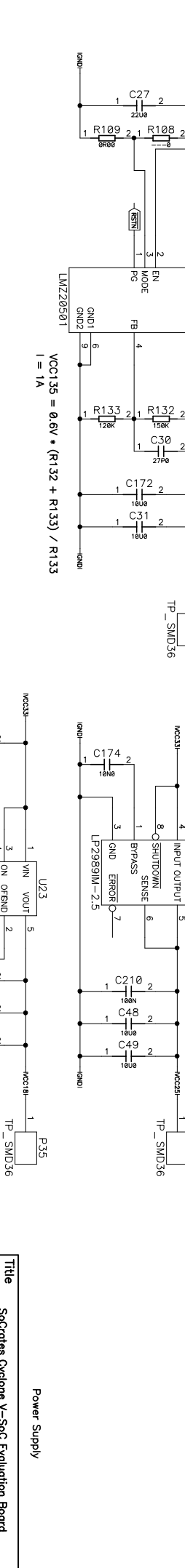
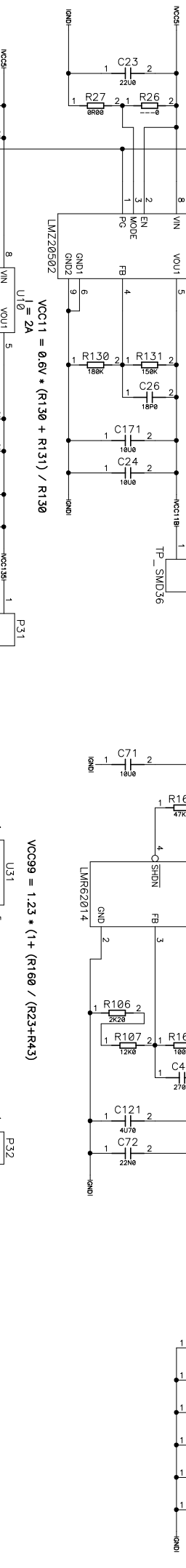
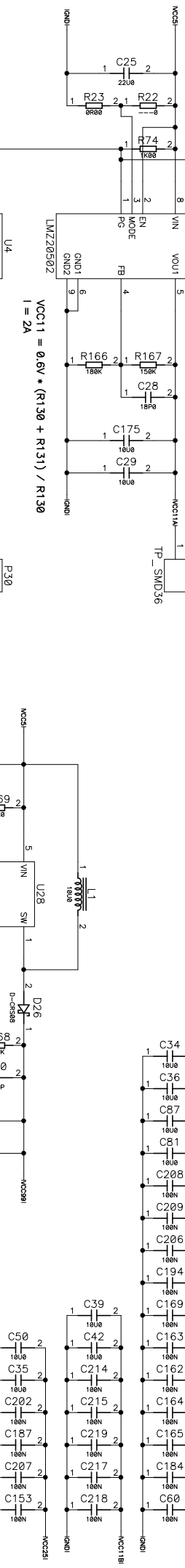
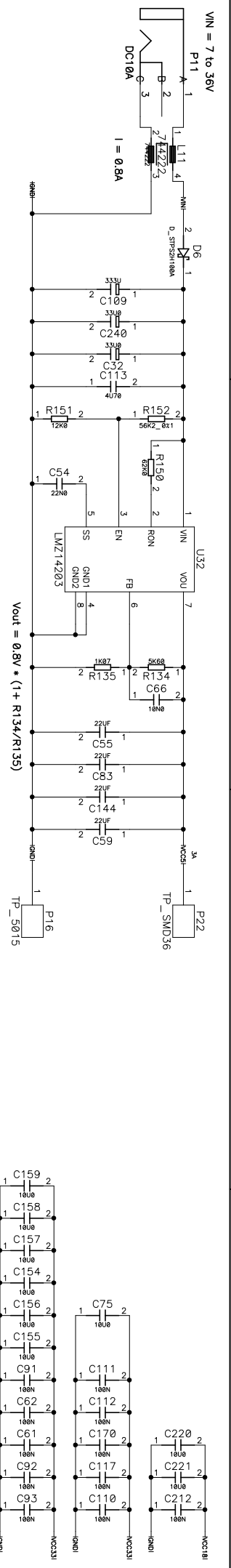

Title		SoCrtcs Cyclone V-Soc Evaluation Board	
Size	Number	Rev	
A3	SoCrtcs	1.1	
Date	Drawn by		
09.03.2013	Filtename SoCrtcs.sch		Sheet 8 of 10

Power Supply





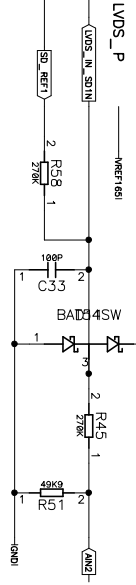
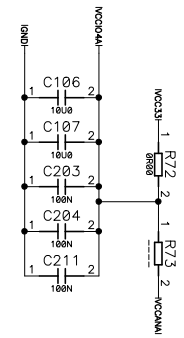
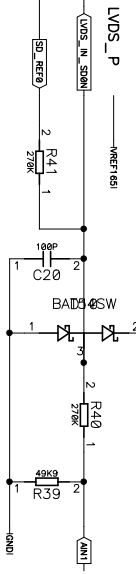
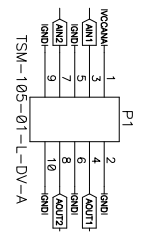
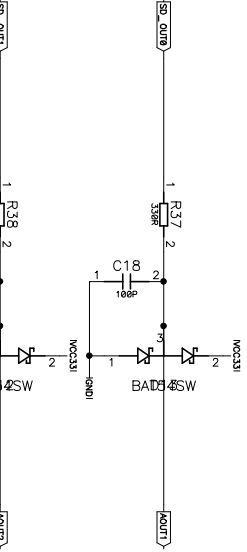
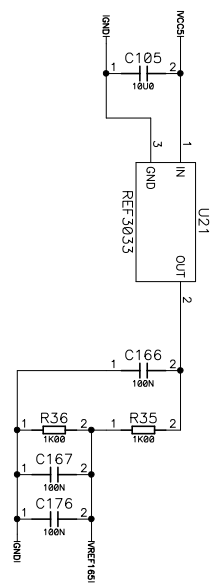

SD-ADC / DAC

Title		SoCrtas Cyclone V-Soc Evaluation Board	
Size	Number	Rev	Rev
A3	SoCrtas	1.1	1.1
Date	Drawn by		
09.03.2013	Filipme SoCrtas.sch		Sheet 10 of 10